

One less worry ...



**... when it comes to choosing
Enteral Feeding Tubes.**

KIMBERLY-CLARK* MIC*
Percutaneous Endoscopic Gastrostomy (PEG) Feeding Tubes/Kits

- Medical Grade Silicone Construction
- SECUR-LOK* External Retention Ring
- Universal and Bolus Feeding Port Connectors
- Medication Port
- Collapsible Internal Retention Bumper
- Radiopaque Stripe and Bumper
- Tubing Clamp
- Available in PUSH (OTW) and PULL Placement Methods
- Ethylene Oxide (ETO) Sterilised

Deluxe 0630-XX Series
PUSH PEG Kit Includes:

- 1- Traction Removable PUSH PEG Tube
- 1- 5 Fr Retrieval Snare (1.8mm x 260cm)
- 1- 0136-XX Bolus Feeding Adapter
- 1- 0137-XX Threaded Feeding Adapter
- 1- SECUR-LOK* External Retention Ring
- 1- 22ga x 1 1/2", 3.81cm Filter Needle
- 1- 25ga x 1.5875cm Needle
- 1- 25ga x 1.5875cm Needle
- 1- Fenestrated Drape with Adhesive Tabs
- 1- 12ml Syringe
- 1- Disposable Scalpel with #11 Blade
- 1- 14ga x 2.75", 6.985cm Introducer Needle
- 1- Guidewire (.038" x 260cm)
- 1- Tubing Clamp
- 4- 4" x 4", 10.16cm x 10.16cm Gauze Pads
- 2- 2" x 2", 5.08cm x 5.08cm in Slit Gauze Pads
- 1- Suture Strand
- 1- Directions for Use

Deluxe 0640-XX Series
PULL PEG Kit Includes:

- 1- Traction Removable PULL PEG Tube
- 1- 5 Fr Retrieval Snare (1.8mm x 260cm)
- 1- 0136-XX Bolus Feeding Adapter
- 1- 0137-XX Threaded Feeding Adapter
- 1- SECUR-LOK* External Retention Ring
- 1- 22ga x 1.5", 3.81cm Filter Needle
- 1- 19ga x 1.5", 3.81cm Filter Needle
- 1- 25ga x 1.5875cm Needle
- 1- Fenestrated Drape with Adhesive Tabs
- 1- 12ml Syringe
- 1- Disposable Scalpel with #11 Blade
- 1- 14ga x 2.75", 6.985cm Introducer Needle
- 1- Looped Placement Wire
- 1- Tubing Clamp
- 4- 4" x 4", 10.16cm x 10.16cm Gauze Pads
- 2- 2" x 2", 5.08cm x 5.08cm in Slit Gauze Pads
- 1- Suture Strand
- 1- Directions for Use

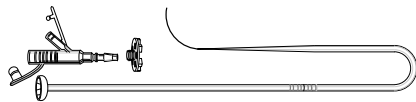

PUSH

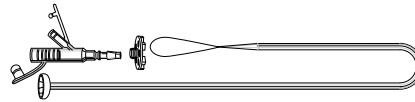

PULL

Code	Size (Outer Diameter)	Description	Packaging
0630-14	14 Fr	PUSH (Over-the-Wire) Method	1 Each
0630-20	20 Fr	PUSH (Over-the-Wire) Method	1 Each
0630-24	24 Fr	PUSH (Over-the-Wire) Method	1 Each
0640-14	14 Fr	PULL Method	1 Each
0640-20	20 Fr	PULL Method	1 Each
0640-24	24 Fr	PULL Method	1 Each

Deluxe 0644-XX Series Basic PULL PEG Kit Contents:

- 1- Traction Removable PULL PEG Tube
- 1- 0136-XX Bolus Feeding Adapter
- 1- 0137-XX Threaded Feeding Adapter
- 1- SECUR-LOK* External Retention Ring
- 1- Disposable Scalpel with #11 Blade
- 1- 14ga x 6.985cm (23/4") Introducer Needle
- 1- Looped Placement Wire
- 1- Tubing Clamp
- 1- Directions for Use

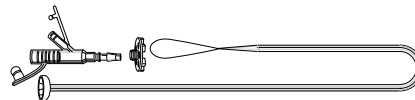

Code	Size (Outer Diameter)	Description	PULL	Packaging
0644-14	14 Fr	Basic PULL Peg Kit		1 Each
0644-20	20 Fr	Basic PULL Peg Kit		1 Each
0644-24	24 Fr	Basic PULL Peg Kit		1 Each

KIMBERLY-CLARK* MIC* Percutaneous Endoscopic Gastrostomy Feeding Tube Accessories

For use with MIC* Percutaneous Endoscopic Gastrostomy Feeding Tubes

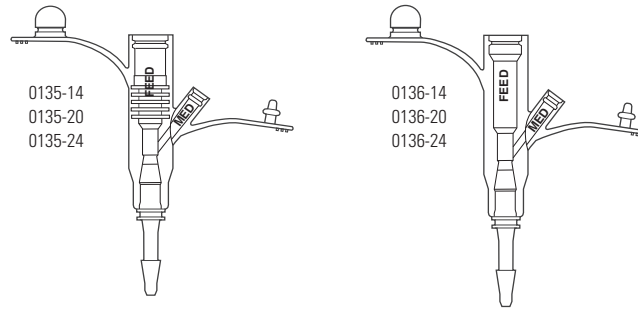

Code	Description	Packaging
0135-14	Universal Feeding Adapter – For use with 14 Fr MIC* PEG	1 Each
0135-20	Universal Feeding Adapter – For use with 20 Fr MIC* PEG	1 Each
0135-24	Universal Feeding Adapter – For use with 24 Fr MIC* PEG	1 Each
0136-14	Bolus Feeding Adapter – For use with 14 Fr MIC* PEG	1 Each
0136-20	Bolus Feeding Adapter – For use with 20 Fr MIC* PEG	1 Each
0136-24	Bolus Feeding Adapter – For use with 24 Fr MIC* PEG	1 Each

NOTE: Please see package inserts for directions for use for each of these Digestive Health products.

KIMBERLY-CLARK MIC*
Gastrostomy Feeding Tubes

- Medical Grade Silicone Construction
- Silicone Internal Retention Balloon
- SECUR-LOK* External Retention Ring
- Universal Feeding Port Connector
- Medication Port
- Tapered Distal Tip
- Dual Exit Ports
- Radiopaque Stripe
- Gamma Sterilised

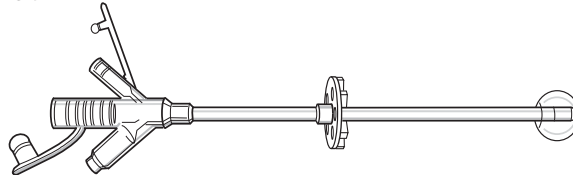

Code	Size (Outer Diameter)	Balloon Volume	Packaging
0112-12LV	12 Fr	3-5ml Balloon	1 Each
0112-14LV	14 Fr	3-5ml Balloon	1 Each
0112-16LV	16 Fr	3-5ml Balloon	1 Each
0112-18	18 Fr	7-10ml Balloon	1 Each
0112-20	20 Fr	7-10ml Balloon	1 Each
0112-22	22 Fr	7-10ml Balloon	1 Each
0112-24	24 Fr	7-10ml Balloon	1 Each

KIMBERLY-CLARK MIC*
Bolus Gastrostomy Feeding Tubes

- Medical Grade Silicone Construction
- Silicone Internal Retention Balloon
- SECUR-LOK* External Retention Ring
- Tapered Distal Tip
- Dual Exit Ports
- Radiopaque Stripe
- Gamma Sterilised

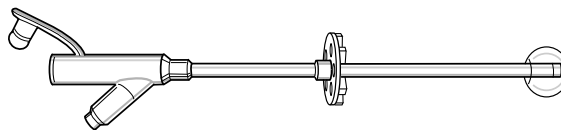

Code	Size (Outer Diameter)	Balloon Volume	Packaging
0100-14LV	14 Fr	3-5ml Balloon	1 Each
0100-16LV	16 Fr	3-5ml Balloon	1 Each
0100-18	18 Fr	7-10ml Balloon	1 Each
0100-20	20 Fr	7-10ml Balloon	1 Each
0100-22	22 Fr	7-10ml Balloon	1 Each
0100-24	24 Fr	7-10ml Balloon	1 Each
0100-26	26 Fr	7-10ml Balloon	1 Each
0100-28	28 Fr	7-10ml Balloon	1 Each
0100-30	30 Fr	7-10ml Balloon	1 Each

NOTE: Please see package inserts for directions for use for each of these Digestive Health products.

KIMBERLY-CLARK MIC* Gastrostomy Feeding Tubes

- Medical Grade Silicone Construction For Visibility And Drapability
- Clearly Marked Feeding, Medication And Balloon Ports For Ease Of Identification
- Ventilated External Retention Ring Designed To Allow Air To Circulate Around The Stoma Site And To Reduce Pressure 360° From The Stoma
- Radiopaque Stripe To Aid In Catheter Visualisation
- Graduated Centimetre Markings For Tube Position Verification
- Luer-Lok* Balloon Port To Ensure Secure Syringe Connection (Also Compatible With Luer-Slip* Syringes)
- Colour-Coded Balloon Port According To Catheter French Size For Ease Of Identification

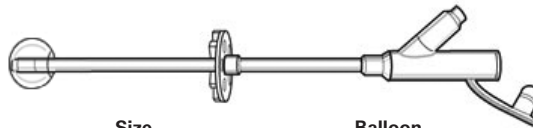

Code	Size (Outer Diameter)	Balloon Volume	Packaging
0110-14LV	14 Fr	3-5ml Balloon	1 Each
0110-16LV	16 Fr	3-5ml Balloon	1 Each
0110-18	18 Fr	7-10ml Balloon	1 Each
0110-20	20 Fr	7-10ml Balloon	1 Each
0110-22	22 Fr	7-10ml Balloon	1 Each
0110-24	24 Fr	7-10ml Balloon	1 Each

KIMBERLY-CLARK MIC-KEY*
Low-Profile Gastrostomy Feeding Tubes/Kits

- Medical Grade Silicone Construction
- Low-Profile Design
- Tapered Distal Tip
- Silicone Internal Retention Balloon
- Distal Tip Recessed at 5ml
- Proximal Anti-Reflux Valve
- SECUR-LOK* Extension Set Connector Mechanism
- Radiopaque Stripe
- Wide Variety of Extension Sets Available
- Gamma Sterilised

Kit Includes:

- 1- MIC-KEY* Low-Profile Feeding Tube
- 1- MIC-KEY* Extension Set with SECUR-LOK
Right Angle Connector and 2 Port "Y" and Clamp – 12", 30.5cm Length
- 1- MIC-KEY* Bolus Extension Set with Cath Tip, SECUR-LOK*
Straight Connector and Clamp – 12", 30.5cm Length
- 1- 6ml Syringe
- 1- 35ml Catheter Tip Syringe
- 4- Gauze Pads

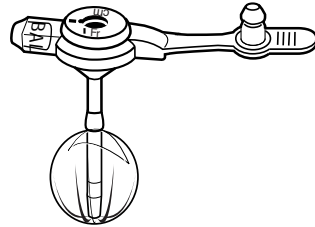

Code	Size (Outer Diameter)	Stoma Length	Balloon Volume	Packaging
0120-12-0.8	12 Fr	0.8cm	3-5ml Balloon	1 Each
0120-12-1.0	12 Fr	1cm	3-5ml Balloon	1 Each
0120-12-1.2	12 Fr	1.2cm	3-5ml Balloon	1 Each
0120-12-1.5	12 Fr	1.5cm	3-5ml Balloon	1 Each
0120-12-1.7	12 Fr	1.7cm	3-5ml Balloon	1 Each
0120-12-2.0	12 Fr	2cm	3-5ml Balloon	1 Each
0120-12-2.3	12 Fr	2.3cm	3-5ml Balloon	1 Each
0120-12-2.5	12 Fr	2.5cm	3-5ml Balloon	1 Each
0120-12-2.7	12 Fr	2.7cm	3-5ml Balloon	1 Each
0120-12-3.0	12 Fr	3cm	3-5ml Balloon	1 Each
0120-12-3.5	12 Fr	3.5cm	3-5ml Balloon	1 Each
0120-12-4.0	12 Fr	4cm	3-5ml Balloon	1 Each
0120-12-4.5	12 Fr	4.5cm	3-5ml Balloon	1 Each
0120-14-0.8	14 Fr	0.8cm	5ml Balloon	1 Each
0120-14-1.0	14 Fr	1.0cm	5ml Balloon	1 Each
0120-14-1.2	14 Fr	1.2cm	5ml Balloon	1 Each
0120-14-1.5	14 Fr	1.5cm	5ml Balloon	1 Each
0120-14-1.7	14 Fr	1.7cm	5ml Balloon	1 Each
0120-14-2.0	14 Fr	2.0cm	5ml Balloon	1 Each
0120-14-2.3	14 Fr	2.3cm	5ml Balloon	1 Each
0120-14-2.5	14 Fr	2.5cm	5ml Balloon	1 Each
0120-14-2.7	14 Fr	2.7cm	5ml Balloon	1 Each
0120-14-3.0	14 Fr	3.0cm	5ml Balloon	1 Each
0120-14-3.5	14 Fr	3.5cm	5ml Balloon	1 Each
0120-14-4.0	14 Fr	4.0cm	5ml Balloon	1 Each
0120-14-4.5	14 Fr	4.5cm	5ml Balloon	1 Each
0120-14-5.0	14 Fr	5cm	5ml Balloon	1 Each

Continued over page

KIMBERLY-CLARK® MIC-KEY®
Low-Profile Gastrostomy Feeding Tubes/Kits (cont'd)

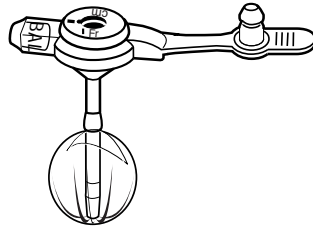

Code	Size (Outer Diameter)	Stoma Length	Balloon Volume	Packaging
0120-16-0.8	16 Fr	0.8cm	5ml Balloon	1 Each
0120-16-1.0	16 Fr	1.0cm	5ml Balloon	1 Each
0120-16-1.2	16 Fr	1.2cm	5ml Balloon	1 Each
0120-16-1.5	16 Fr	1.5cm	5ml Balloon	1 Each
0120-16-1.7	16 Fr	1.7cm	5ml Balloon	1 Each
0120-16-2.0	16 Fr	2.0cm	5ml Balloon	1 Each
0120-16-2.3	16 Fr	2.3cm	5ml Balloon	1 Each
0120-16-2.5	16 Fr	2.5cm	5ml Balloon	1 Each
0120-16-2.7	16 Fr	2.7cm	5ml Balloon	1 Each
0120-16-3.0	16 Fr	3.0cm	5ml Balloon	1 Each
0120-16-3.5	16 Fr	3.5cm	5ml Balloon	1 Each
0120-16-4.0	16 Fr	4.0cm	5ml Balloon	1 Each
0120-16-4.5	16 Fr	4.5cm	5ml Balloon	1 Each
0120-16-5.0	16 Fr	5cm	5ml Balloon	1 Each
0120-18-0.8	18 Fr	0.8cm	5ml Balloon	1 Each
0120-18-1.0	18 Fr	1.0cm	5ml Balloon	1 Each
0120-18-1.2	18 Fr	1.2cm	5ml Balloon	1 Each
0120-18-1.5	18 Fr	1.5cm	5ml Balloon	1 Each
0120-18-1.7	18 Fr	1.7cm	5ml Balloon	1 Each
0120-18-2.0	18 Fr	2.0cm	5ml Balloon	1 Each
0120-18-2.3	18 Fr	2.3cm	5ml Balloon	1 Each
0120-18-2.5	18 Fr	2.5cm	5ml Balloon	1 Each
0120-18-2.7	18 Fr	2.7cm	5ml Balloon	1 Each
0120-18-3.0	18 Fr	3.0cm	5ml Balloon	1 Each
0120-18-3.5	18 Fr	3.5cm	5ml Balloon	1 Each
0120-18-4.0	18 Fr	4.0cm	5ml Balloon	1 Each
0120-18-4.5	18 Fr	4.5cm	5ml Balloon	1 Each
0120-18-5.0	18 Fr	5.0cm	5ml Balloon	1 Each

Continued over page

KIMBERLY-CLARK® MIC-KEY®
Low-Profile Gastrostomy Feeding Tubes/Kits (cont'd)

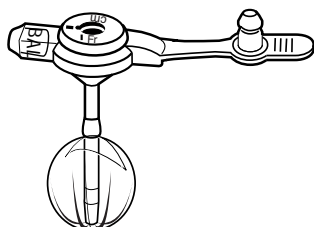

Code	Size (Outer Diameter)	Stoma Length	Balloon Volume	Packaging
0120-20-0.8	20 Fr	0.8cm	5ml Balloon	1 Each
0120-20-1.0	20 Fr	1.0cm	5ml Balloon	1 Each
0120-20-1.2	20 Fr	1.2cm	5ml Balloon	1 Each
0120-20-1.5	20 Fr	1.5cm	5ml Balloon	1 Each
0120-20-1.7	20 Fr	1.7cm	5ml Balloon	1 Each
0120-20-2.0	20 Fr	2.0cm	5ml Balloon	1 Each
0120-20-2.3	20 Fr	2.3cm	5ml Balloon	1 Each
0120-20-2.5	20 Fr	2.5cm	5ml Balloon	1 Each
0120-20-2.7	20 Fr	2.7cm	5ml Balloon	1 Each
0120-20-3.0	20 Fr	3.0cm	5ml Balloon	1 Each
0120-20-3.5	20 Fr	3.5cm	5ml Balloon	1 Each
0120-20-4.0	20 Fr	4.0cm	5ml Balloon	1 Each
0120-20-4.5	20 Fr	4.5cm	5ml Balloon	1 Each
0120-20-5.0	20 Fr	5.0cm	5ml Balloon	1 Each
0120-24-1.5	24 Fr	1.5cm	5ml Balloon	1 Each
0120-24-1.7	24 Fr	1.7cm	5ml Balloon	1 Each
0120-24-2.0	24 Fr	2.0cm	5ml Balloon	1 Each
0120-24-2.3	24 Fr	2.3cm	5ml Balloon	1 Each
0120-24-2.5	24 Fr	2.5cm	5ml Balloon	1 Each
0120-24-2.7	24 Fr	2.7cm	5ml Balloon	1 Each
0120-24-3.0	24 Fr	3.0cm	5ml Balloon	1 Each
0120-24-3.5	24 Fr	3.5cm	5ml Balloon	1 Each
0120-24-4.0	24 Fr	4.0cm	5ml Balloon	1 Each
0120-24-4.5	24 Fr	4.5cm	5ml Balloon	1 Each
0120-24-5.0	24 Fr	5.0cm	5ml Balloon	1 Each

KIMBERLY-CLARK* MIC-KEY* Feeding Tube Accessories

For use with MIC-KEY* Low-Profile Gastrostomy and Jejunal Feeding Tubes

- Proximal Tip Types: 2 Port "Y", Bolus, and Threaded
- SECUR-LOK* "Key" Connection Mechanism
- Clear Tubing
- Medication Port on Non-Bolus Extension Sets
- Individually Packaged Extension Sets
- Tubing Clamp
- Extension Sets Non-Sterile
- Stoma Measuring Device Gamma Sterilised

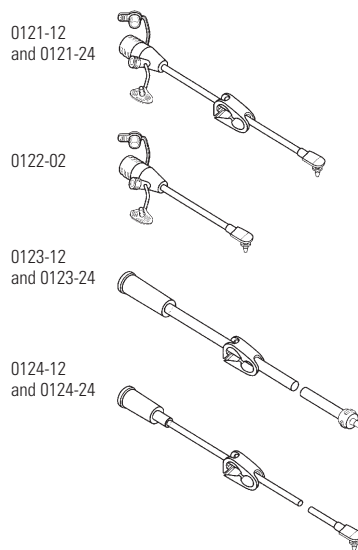

DEHP-Free Formulation Code	Standard Formulation Code	Length	Description	Packaging
0121-12	0221-12	30.5cm 12"	MIC-KEY* Extension Set with SECUR-LOK* Right Angle Connector and 2 Port "Y" and Clamp	5 Each
0121-24	0221-24	60.9cm 24"	MIC-KEY* Extension Set with SECUR-LOK* Right Angle Connector and 2 Port "Y" and Clamp	5 Each
0122-02		5.1cm 2"	MIC-KEY* Medication Set with SECUR-LOK* Right Angle Connector and 2 Port "Y"	5 Each
0123-12	0223-12	30.5cm 12"	MIC-KEY* Bolus Extension Set with Cath Tip, SECUR-LOK* Straight Connector and Clamp	5 Each
0123-24		60.9cm 24"	MIC-KEY* Bolus Extension Set with Cath Tip, SECUR-LOK* Straight Connector and Clamp	5 Each
0124-12		30.5cm 12"	MIC-KEY* Bolus Extension Set with Cath Tip, SECUR-LOK* Right Angle Connector and Clamp	5 Each
0124-24		60.9cm 24"	MIC-KEY* Bolus Extension Set with Cath Tip, SECUR-LOK* Right Angle Connector and Clamp	5 Each
0126-12		30.5cm 12"	MIC-KEY* Threaded Extension Set With SECUR-LOK* Right Angle Connector and Clamp	5 Each
0126-24		60.9cm 24"	MIC-KEY* Threaded Extension Set With SECUR-LOK* Right Angle Connector and Clamp	5 Each
98460			MIC-KEY* Stoma Measuring Device	10 Each

NOTE: Please see package inserts for directions for use for each of these Digestive Health products.

KIMBERLY-CLARK MIC*
Transgastric-Jejunal Feeding Tubes –
Endoscopic / Radiology Placement

- Medical Grade Silicone Construction
- Silicone Internal Retention Balloon
- SECUR-LOK* External Retention Ring
- Universal Jejunal Feeding Port Connector
- Gastric Decompression Port
- Multiple Gastric & Jejunal Exit Ports
- Tungsten Weighted Jejunal Portion
- Tapered Distal Tip
- Radiopaque Stripe
- Ethylene Oxide (ETO) Sterilised

Kit Includes:

- 1- Transgastric Jejunal Feeding Tube
- 1- Silicone Coated Guidewire
- 1- Luer-Slip™ Syringe
- 1- 35ml Catheter Tip Syringe
- 1- SECUR-LOK* External Retention Ring
- 1- Directions for Use
- 1- Patient Care Guidelines

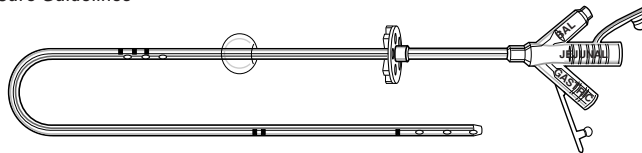

Code	Size (Outer Diameter)	Jejunal Length+	Balloon Volume	Packaging
0650-16-15	16 Fr	15cm	7-10ml Balloon	1 Each
0650-16-22	16 Fr	22cm	7-10ml Balloon	1 Each
0650-16-30	16 Fr	30cm	7-10ml Balloon	1 Each
0650-16	16 Fr	45cm	7-10ml Balloon	1 Each
0650-18-22	18 Fr	22cm	7-10ml Balloon	1 Each
0650-18-30	18 Fr	30cm	7-10ml Balloon	1 Each
0650-18	18 Fr	45cm	7-10ml Balloon	1 Each
0650-22	22 Fr	45cm	7-10ml Balloon	1 Each

+Jejunal length measured from the distal aspect of the retention balloon to the catheter tip.

KIMBERLY-CLARK* MIC-KEY* **Low-Profile Transgastric-Jejunal Tubes –** **Endoscopic/Radiology Placement Kits**

- Unobtrusive and easy to conceal
- Multiple feeding exit ports to help improve flow and minimise clogging
- Tungsten weighted jejunal portion to maintain jejunal position
- Radiopaque stripe to help aid in catheter visualisation
- Clearly marked separate gastric and jejunal ports for ease of identification
- High-clarity medical grade silicone designed for visibility and drapability
- Tapered distal tip for non-traumatic tube insertion

Kit Includes:

- 1 – MIC-KEY* Low-Profile Transgastric-Jejunal Feeding Tube
- 1 – Introducer Cannula
- 1 – MIC-KEY* Extension Set with SECUR-LOK* Right Angle Connector and 2 Port "Y" and Clamp – 12", 30.5cm Length
- 1 – MIC-KEY* Bolus Extension Set with Cath Tip, SECUR-LOK* Straight Connector and Clamp – 12", 30.5cm Length
- 1 – 6ml Luer-Slip™ Syringe
- 4 – Gauze Pads
- 1 – Directions For Use
- 1 – Patient Care Guidelines

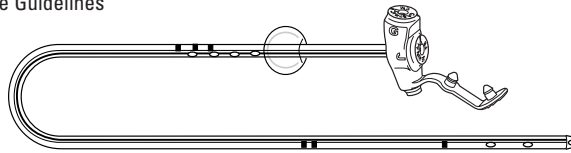

Code	Size (Outer Diameter)	Stoma Length	Jejunal Length+	Balloon Volume	Packaging
0270-16-1.0-15	16 Fr	1.0cm	15cm	3-5ml Balloon	1 Each
0270-16-1.0-22	16 Fr	1.0cm	22cm	3-5ml Balloon	1 Each
0270-16-1.2-15	16 Fr	1.2cm	15cm	3-5ml Balloon	1 Each
0270-16-1.2-22	16 Fr	1.2cm	22cm	3-5ml Balloon	1 Each
0270-16-1.2-30	16 Fr	1.2cm	30cm	3-5ml Balloon	1 Each
0270-16-1.5-15	16 Fr	1.5cm	15cm	3-5ml Balloon	1 Each
0270-16-1.5-22	16 Fr	1.5cm	22cm	3-5ml Balloon	1 Each
0270-16-1.5-30	16 Fr	1.5cm	30cm	3-5ml Balloon	1 Each
0270-16-1.5-45	16 Fr	1.5cm	45cm	7-10ml Balloon	1 Each
0270-16-1.7-15	16 Fr	1.7cm	15cm	3-5ml Balloon	1 Each
0270-16-1.7-22	16 Fr	1.7cm	22cm	3-5ml Balloon	1 Each
0270-16-1.7-30	16 Fr	1.7cm	30cm	3-5ml Balloon	1 Each
0270-16-1.7-45	16 Fr	1.7cm	45cm	7-10ml Balloon	1 Each
0270-16-2.0-22	16 Fr	2.0cm	22cm	3-5ml Balloon	1 Each
0270-16-2.0-30	16 Fr	2.0cm	30cm	3-5ml Balloon	1 Each
0270-16-2.0-45	16 Fr	2.0cm	45cm	7-10ml Balloon	1 Each
0270-16-2.3-30	16 Fr	2.3cm	30cm	3-5ml Balloon	1 Each
0270-16-2.3-45	16 Fr	2.3cm	45cm	7-10ml Balloon	1 Each
0270-16-2.5-30	16 Fr	2.5cm	30cm	3-5ml Balloon	1 Each
0270-16-2.7-30	16 Fr	2.7cm	30cm	3-5ml Balloon	1 Each

Continued over page

KIMBERLY-CLARK MIC-KEY*
Low-Profile Transgastric-Jejunal Tubes –
Endoscopic/Radiology Placement Kits (cont'd)

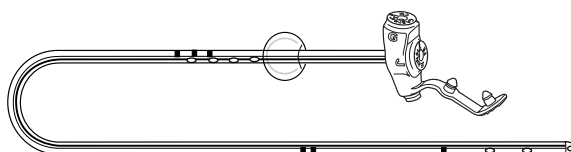

Code	Size (Outer Diameter)	Stoma Length	Jejunal Length+	Balloon Volume	Packaging
0270-18-1.2-22	18 Fr	1.2cm	22cm	3-5ml Balloon	1 Each
0270-18-1.2-30	18 Fr	1.2cm	30cm	3-5ml Balloon	1 Each
0270-18-1.5-22	18 Fr	1.5cm	22cm	3-5ml Balloon	1 Each
0270-18-1.5-30	18 Fr	1.5cm	30cm	3-5ml Balloon	1 Each
0270-18-1.5-45	18 Fr	1.5cm	45cm	7-10ml Balloon	1 Each
0270-18-1.7-22	18 Fr	1.7cm	22cm	3-5ml Balloon	1 Each
0270-18-1.7-30	18 Fr	1.7cm	30cm	3-5ml Balloon	1 Each
0270-18-1.7-45	18 Fr	1.7cm	45cm	7-10ml Balloon	1 Each
0270-18-2.0-22	18 Fr	2.0cm	22cm	3-5ml Balloon	1 Each
0270-18-2.0-30	18 Fr	2.0cm	30cm	3-5ml Balloon	1 Each
0270-18-2.0-45	18 Fr	2.0cm	45cm	7-10ml Balloon	1 Each
0270-18-2.3-30	18 Fr	2.3cm	30cm	3-5ml Balloon	1 Each
0270-18-2.3-45	18 Fr	2.3cm	45cm	7-10ml Balloon	1 Each
0270-18-2.5-30	18 Fr	2.5cm	30cm	3-5ml Balloon	1 Each
0270-18-2.5-45	18 Fr	2.5cm	45cm	7-10ml Balloon	1 Each
0270-18-2.7-30	18 Fr	2.7cm	30cm	3-5ml Balloon	1 Each
0270-18-2.7-45	18 Fr	2.7cm	45cm	7-10ml Balloon	1 Each
0270-18-3.0-45	18 Fr	3.0cm	45cm	7-10ml Balloon	1 Each
0270-18-3.5-45	18 Fr	3.5cm	45cm	7-10ml Balloon	1 Each
0270-22-1.5-45	22 Fr	1.5cm	45cm	7-10ml Balloon	1 Each
0270-22-1.7-45	22 Fr	1.7cm	45cm	7-10ml Balloon	1 Each
0270-22-2.0-45	22 Fr	2.0cm	45cm	7-10ml Balloon	1 Each
0270-22-2.3-45	22 Fr	2.3cm	45cm	7-10ml Balloon	1 Each
0270-22-2.5-45	22 Fr	2.5cm	45cm	7-10ml Balloon	1 Each
0270-22-2.7-45	22 Fr	2.7cm	45cm	7-10ml Balloon	1 Each
0270-22-3.0-45	22 Fr	3.0cm	45cm	7-10ml Balloon	1 Each
0270-22-3.5-45	22 Fr	3.5cm	45cm	7-10ml Balloon	1 Each

+Jejunal length measured from the distal aspect of the retention balloon to the catheter tip.

KIMBERLY-CLARK* MIC* Jejunal Feeding Tubes

Code	Size (Outer Diameter)	Balloon Volume	Packaging
0200-12LV	12 Fr	3-5ml Balloon	1 Each
0200-14	14 Fr	7-10ml Balloon	1 Each
0200-16	16 Fr	7-10ml Balloon	1 Each
0200-18	18 Fr	7-10ml Balloon	1 Each
0200-20	20 Fr	7-10ml Balloon	1 Each
0200-22	22 Fr	7-10ml Balloon	1 Each
0200-24	24 Fr	7-10ml Balloon	1 Each

KIMBERLY-CLARK* MIC-KEY* Low-Profile Jejunal Feeding Tubes

Code	Size (Outer Diameter)	Stoma Length	Balloon Volume	Packaging
0230-14-0.8	14 Fr	0.8cm	5ml Balloon	1 Each
0230-14-1.0	14 Fr	1.0cm	5ml Balloon	1 Each
0230-14-1.2	14 Fr	1.2cm	5ml Balloon	1 Each
0230-14-1.5	14 Fr	1.5cm	5ml Balloon	1 Each
0230-14-1.7	14 Fr	1.7cm	5ml Balloon	1 Each
0230-14-2.0	14 Fr	2.0cm	5ml Balloon	1 Each
0230-14-2.3	14 Fr	2.3cm	5ml Balloon	1 Each
0230-14-2.5	14 Fr	2.5cm	5ml Balloon	1 Each
0230-14-2.7	14 Fr	2.7cm	5ml Balloon	1 Each
0230-14-3.0	14 Fr	3.0cm	5ml Balloon	1 Each
0230-14-3.5	14 Fr	3.5cm	5ml Balloon	1 Each
0230-14-4.0	14 Fr	4.0cm	5ml Balloon	1 Each
0230-14-4.5	14 Fr	4.5cm	5ml Balloon	1 Each
0230-18-0.8	18 Fr	0.8cm	5ml Balloon	1 Each
0230-18-1.0	18 Fr	1.0cm	5ml Balloon	1 Each
0230-18-1.2	18 Fr	1.2cm	5ml Balloon	1 Each
0230-18-1.5	18 Fr	1.5cm	5ml Balloon	1 Each
0230-18-1.7	18 Fr	1.7cm	5ml Balloon	1 Each
0230-18-2.0	18 Fr	2.0cm	5ml Balloon	1 Each
0230-18-2.3	18 Fr	2.3cm	5ml Balloon	1 Each
0230-18-2.5	18 Fr	2.5cm	5ml Balloon	1 Each
0230-18-2.7	18 Fr	2.7cm	5ml Balloon	1 Each
0230-18-3.0	18 Fr	3.0cm	5ml Balloon	1 Each
0230-18-3.5	18 Fr	3.5cm	5ml Balloon	1 Each
0230-18-4.0	18 Fr	4.0cm	5ml Balloon	1 Each
0230-18-4.5	18 Fr	4.5cm	5ml Balloon	1 Each

NOTE: Please see package inserts for directions for use for each of these Digestive Health products.

KIMBERLY-CLARK MIC* Jejunostomy Feeding Tube

- Medical Grade Silicone Construction
- Suture Wings
- 9 Fr Internal Diameter
- Radiopaque Stripe
- Gamma Sterilised

Kit Includes:

- 1- Jejunostomy Tube
- 1- Subcutaneous Extraducer
- 1- Feeding Port Adapter
- 1- Luer-Lok* Cap

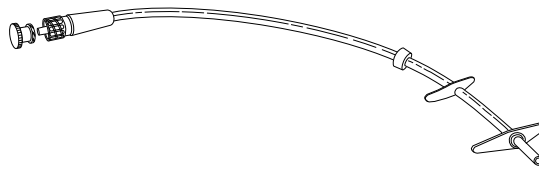

Code	Outer Diameter/ Inner Diameter	Description	Packaging
0301-14	14 Fr/9 Fr	Jejunostomy Feeding Tube	1 Each

KIMBERLY-CLARK MIC* Jejunostomy Feeding Tube Accessories

For use with the MIC* Jejunostomy Feeding Tube

Code	Description	Packaging
0301-50	Jejunostomy Repair Kit – Includes Silicone Med A Medical Adhesive, Stent, Syringe, Blunt Tip Needle, Suture, Silicone Overcollar	1 Each
0301-55	Jejunostomy Luer-Lok* Caps	5 Each
0301-60	Jejunostomy Feeding Port Adapter	5 Each

KIMBERLY-CLARK* MIC* Feeding Tube Accessories

For Use with MIC* Gastrostomy, Bolus Gastrostomy, PEG, Jejunal, Gastro-Enteric, and Transgastric-Jejunal Feeding Tubes. DEHP-Free Formulation [Di-(2-Ethylhexyl)phthalate]



DEHP-Free Formulation Code	Standard Formulation Code	Length	Description	Packaging
0105-06	0205-06	15cm 6"	Extension Tubing with Bolus and Stepped Connectors at Opposite Ends	1 Each
0105-12	0205-12	30cm 12"	Extension Tubing with Bolus and Stepped Connectors at Opposite Ends	1 Each

KIMBERLY-CLARK* Foreign Body Hood Protector

- Non-Sterile
- Disposable



Code	Description	Packaging
69392+	Bell-Shaped, Foreign Body Hood Protector	10 Each

+Caution: This Product Contains Natural Rubber Latex Which May Cause Allergic Reactions.

The KIMBERLY-CLARK ADVANTAGE*

KNOWLEDGE NETWORK* Clinical Education

Online at HALwatch.com
On-site rep-facilitated programs

Knowledgeable Customer Support

In-service training
Product technical support
Unsurpassed customer service

Expert Sales Force

Healthcare Industry Representative Credentialed
On-site trained in hospitals

Infection prevention website:

www.HALwatch.com



Tools & Best Practices

Infection Prevention Education Toolkits
Product Use and Selection Tools
Best Practices/ Industry Guidelines
Cost-in-use Calculators
Inventory Control Tools

Clinical Research

Staff medical professionals to advise and direct clinical research
Clinical Scientific research to measure clinical outcomes in patients
Peer-to-peer consultation

At Kimberly-Clark, we deliver innovative healthcare solutions that you can depend on to meet the demands of your fast-paced world, supported by in-service training, clinical research and accredited education. Whenever your needs involve infection prevention, surgical solutions, digestive health, or Respiratory Health Solutions, with Kimberly-Clark solutions you'll have one less worry.



Protection & Infection
Prevention Solutions



Surgical Solutions



Respiratory Health
Solutions



Digestive Health
Solutions

Visit our website at www.kchealthcare.com

Australia:

Kimberly-Clark Australia Pty. Limited ABN 65 000 032 333
52 Alfred Street, Milsons Point, NSW 2061
To Order: 1800 810 077
Advisory: 1800 101 021
Fax: 1800 012 255

New Zealand:

Kimberly-Clark New Zealand
86 Plunket Avenue, Manukau, 2104 Auckland
Tel: 0800 482 211
Fax: +649 250 2511

Kimberly-Clark makes no representation that its products described in this catalogue will provide complete protection from exposure to contaminants, fluids or micro-organisms or will eliminate the risk of contracting infectious diseases.

* Registered Trademark or Trademark of Kimberly-Clark Worldwide, Inc.

© 2012 KCWW

KCHC2012WFKC369



Kimberly-Clark

Trusted Clinical Solutions*